

Name: \_\_\_\_\_

# Coloring Key Math

4 red	5 orange	6 yellow
7 purple	8 blue	9 pink

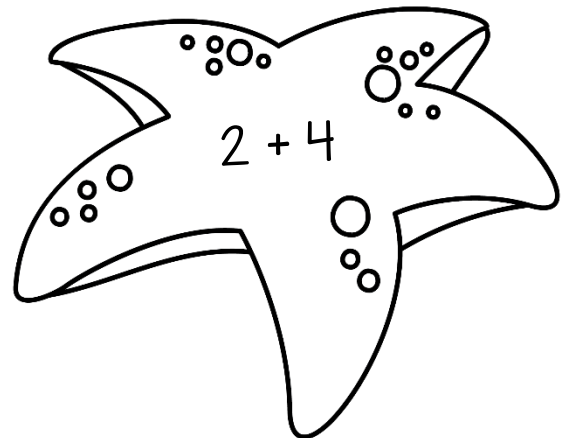
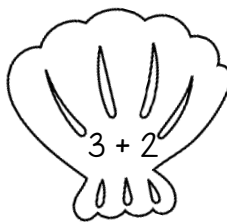
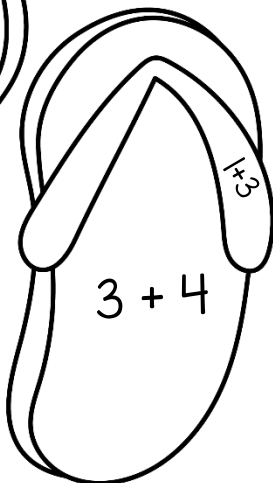
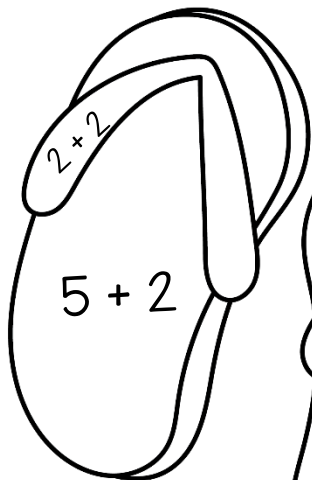
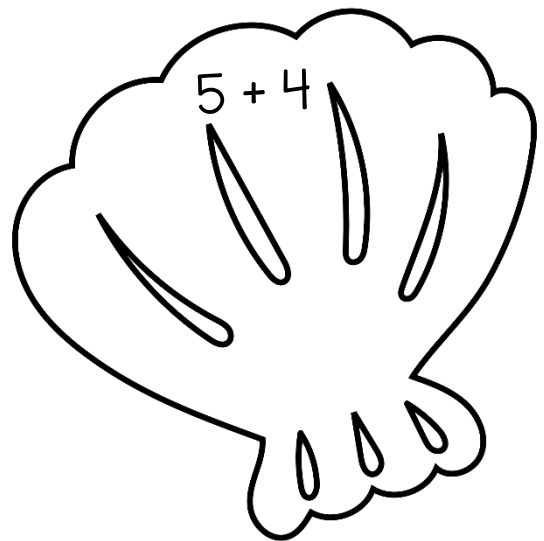
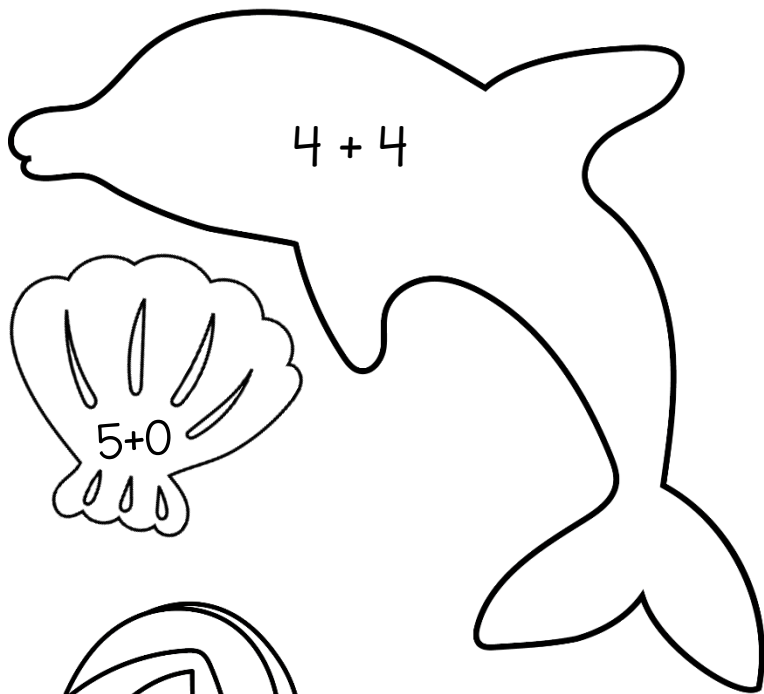

Name: \_\_\_\_\_

# Coloring Key Math

5 red	6 orange	7 yellow
8 purple	9 blue	10 black

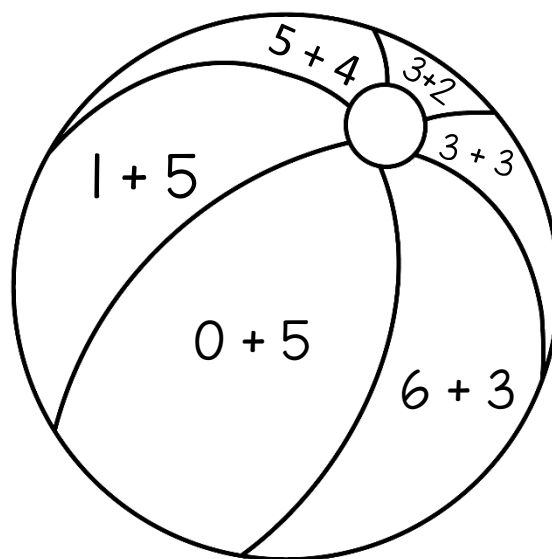
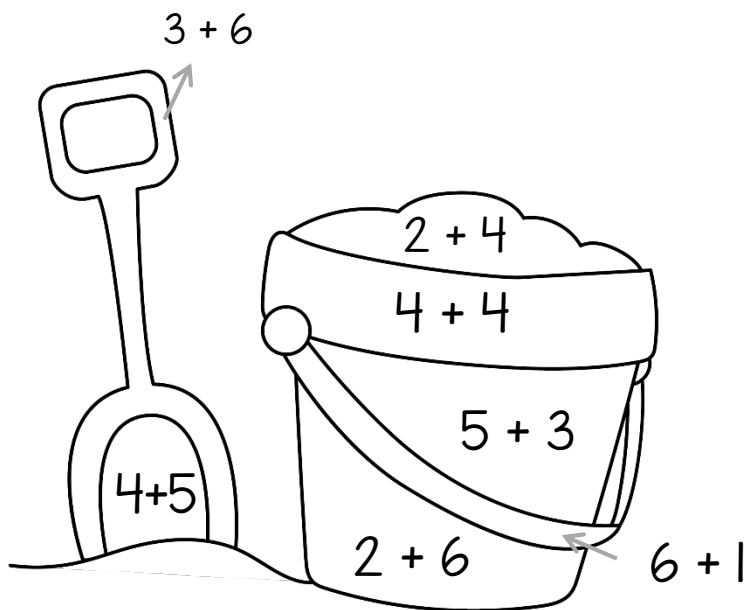
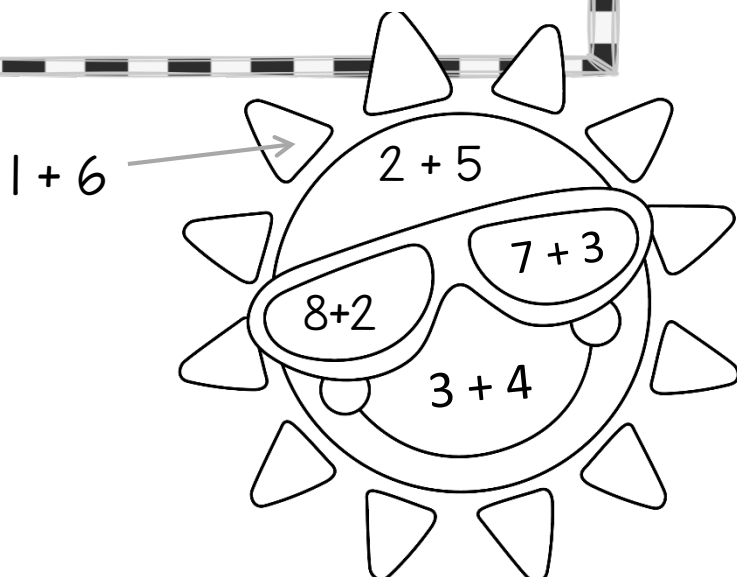
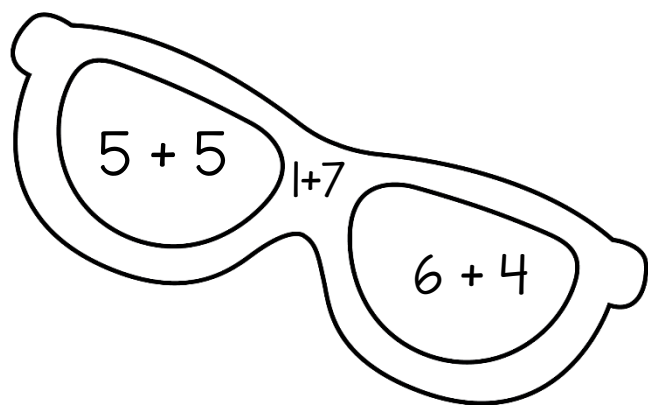

Name: \_\_\_\_\_

## Coloring Key Math

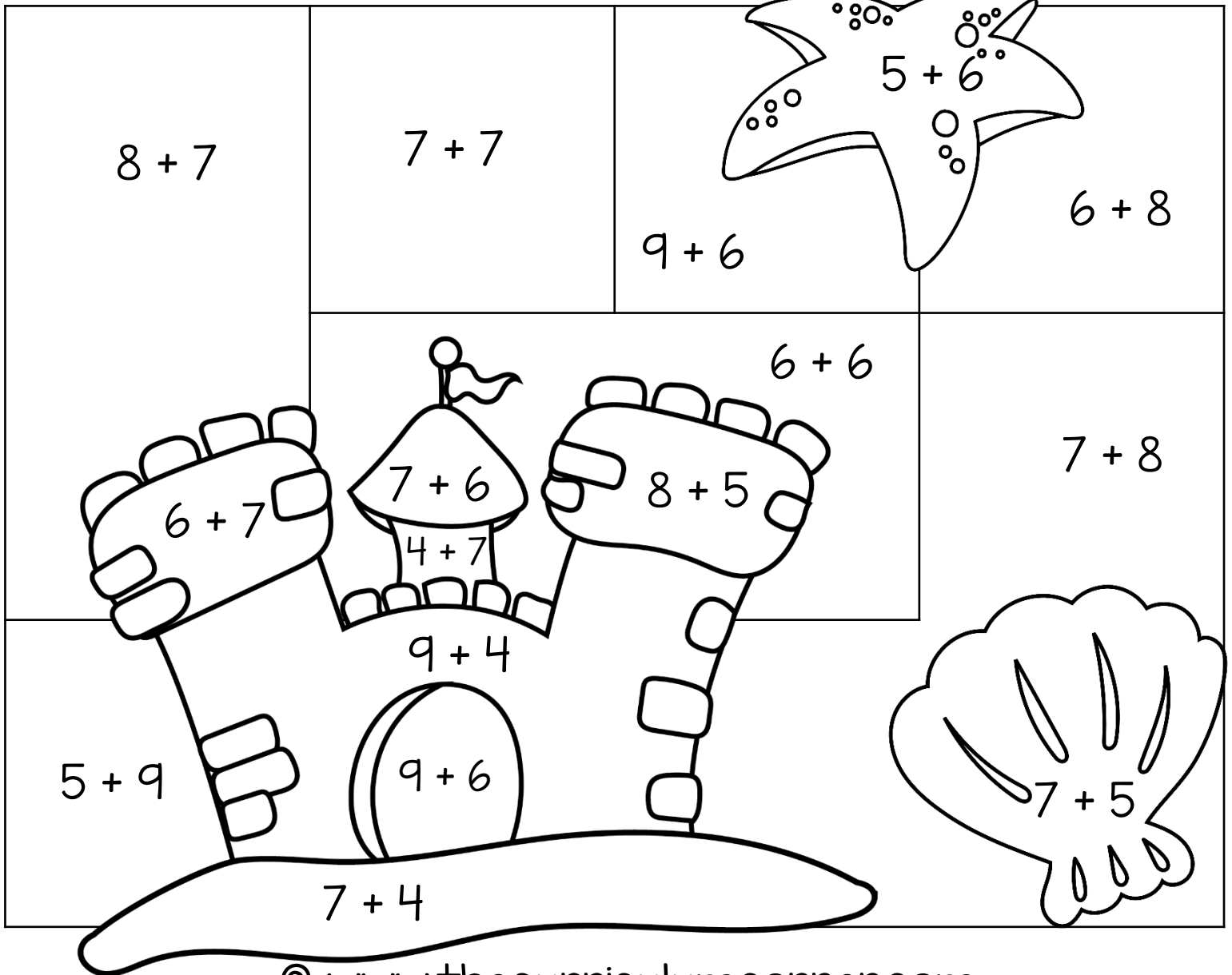
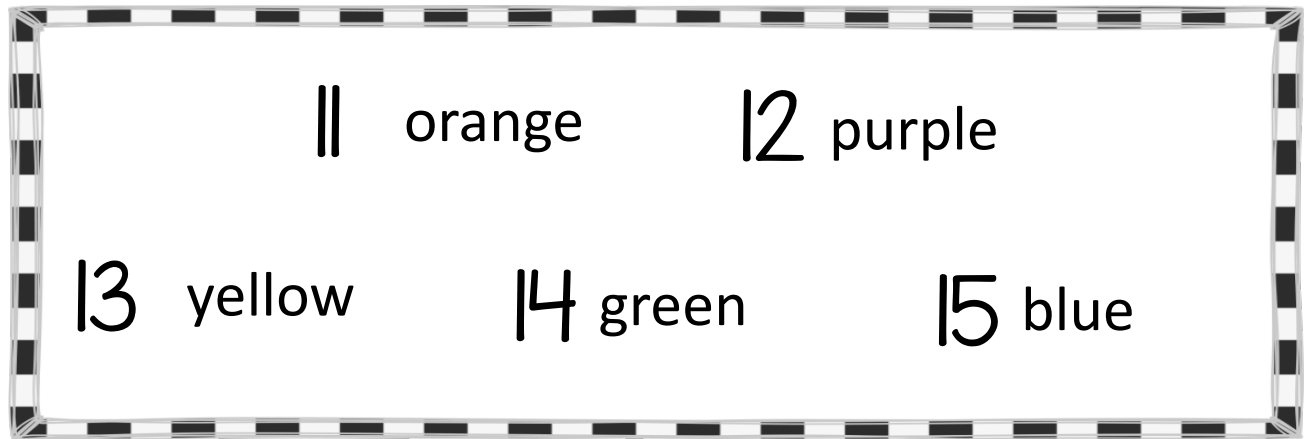

Name: \_\_\_\_\_

## Coloring Key Math

7 orange	8 red	9 purple
10 yellow	11 green	12 blue

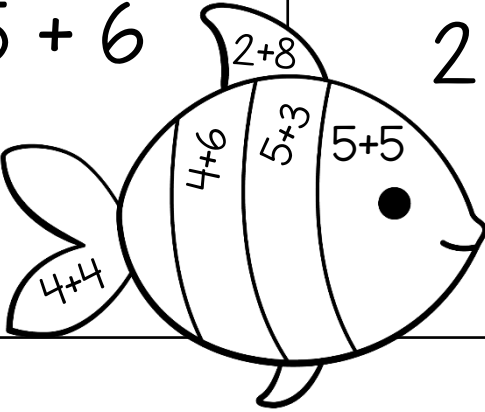
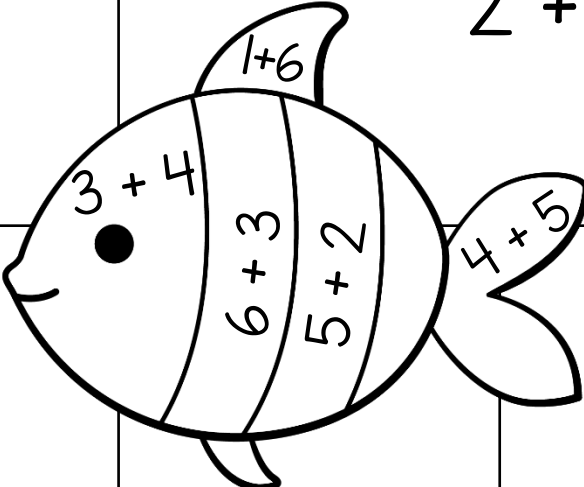
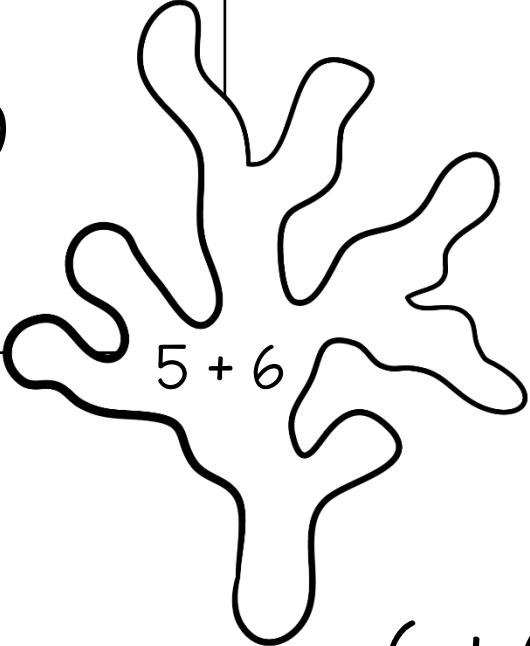
$7 + 5$	$5 + 6$  $2 + 10$	$3 + 8$
$3 + 6$	 $2 + 9$	 $6 + 6$

Name: \_\_\_\_\_

## Coloring Key Math

9	yellow	10	gray
11	red	12	black
13	purple	14	blue

